



# PX-501/ PX-501 B

## Quick Start Guide



### Accessory

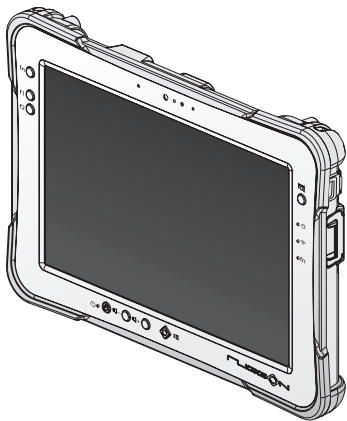

PX-501/PX-501B

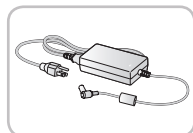

Power Adapter

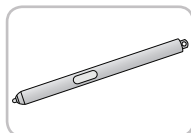

Digitizer

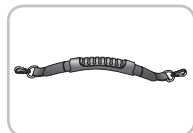

2-Point  
Carrying Handle

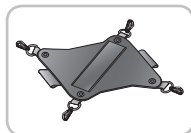

4-Point Handstrap

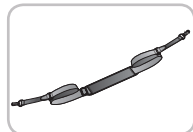

2-Point  
Shoulder Strap

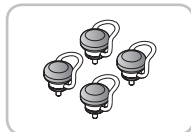

Hitch D-rings  
(Attaching straps)

### Overview

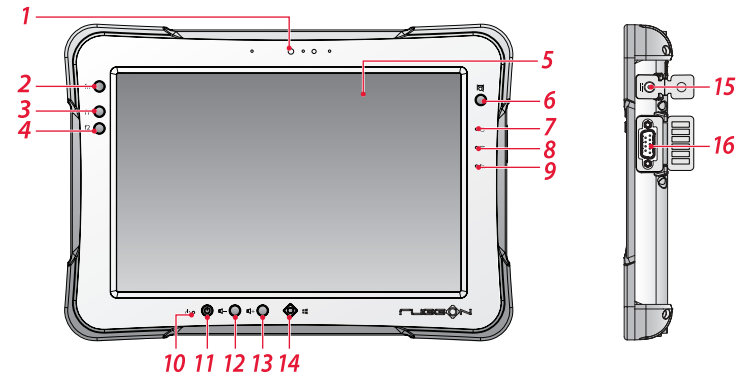

- |                   |               |               |
|-------------------|---------------|---------------|
| 1 Front camera    | 7 Battery LED | 13 Volume +   |
| 2 FN key          | 8 Wi-Fi LED   | 14 Home key   |
| 3 F1 key          | 9 FN LED      | 15 DC-IN jack |
| 4 F2 key          | 10 Power LED  | 16 RS-232     |
| 5 Touch screen    | 11 Power key  |               |
| 6 Barcode trigger | 12 Volume -   |               |

**Note:** To prevent damage or malfunction, always dry the touch screen when wet.

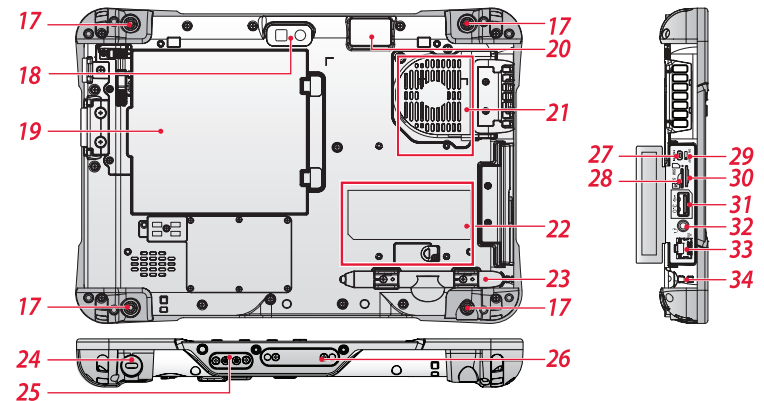

- |                   |                      |                   |
|-------------------|----------------------|-------------------|
| 17 Securing holes | 23 Digitizer holder  | 29 Battery switch |
| 18 Rear camera    | 24 Kensington lock   | 30 Micro SIM slot |
| 19 Battery        | 25 Pass-through      | 31 USB 3.0        |
| 20 Barcode reader | 26 Docking connector | 32 Audio jack     |
| 21 Fan            | 27 Micro HDMI        | 33 Ethernet       |
| 22 Expansion bay  | 28 MicroSD slot      | 34 Tether hole    |

## MicroSD Card

1. Unlock the latch.
2. Open the I/O compartment cover.

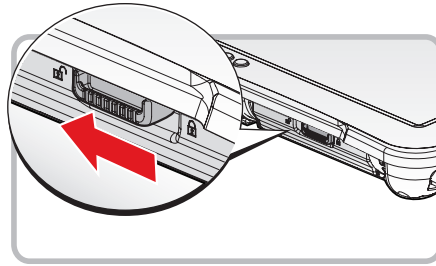

3. Take the microSD card from its packaging.
4. Insert the microSD card into the slot, making sure the beveled edge is aligned in the slot.
5. Press in until an audible click sounds.

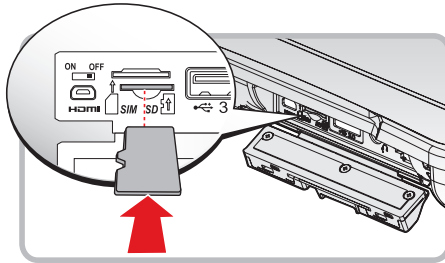

## Charging

1. Flip open the DC-IN cover to expose the DC-IN jack.
2. Connect the AC adapter to the DC-IN port.

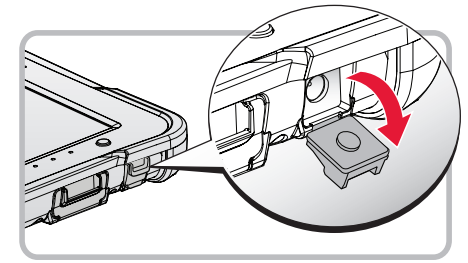

3. After charging, disconnect the AC adapter.
4. Replace the DC-IN cover by angling the rear side at an angle.
5. Press the front open end down in the compartment to seal in place.

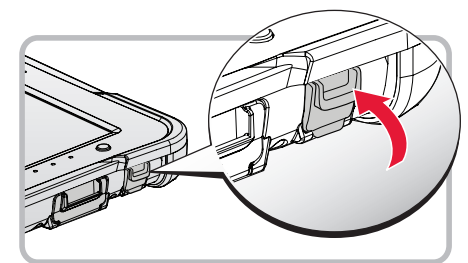

## SIM Card

1. Unlock the latch.
2. Open the I/O compartment cover.

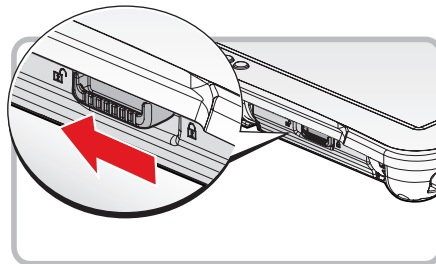

3. Take the SIM card from its packaging.
4. Insert the SIM card into the slot, making sure the beveled edge is aligned in the slot.
5. Press in until an audible click sounds.

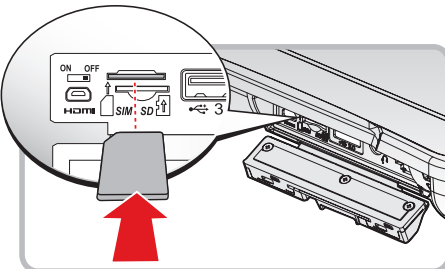

## Power On

1. Open the I/O compartment cover.
2. Switch the DIP switch to the ON position.

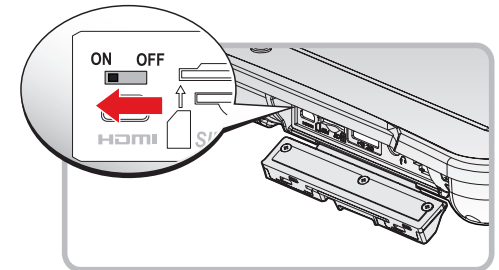

3. Press and hold the power button until the screen lights. The device runs through the start up sequence and powers up.

